



STL

旭環科技 熱銷商品

2017

STL Proprietary & confidential

光源類-燈泡類



環保



減碳



節能



安全



STL



球泡系列



MR 16 系列



GU10 系列



PAR系列



AR111系列

3~13W	3~7W	3~10W	5~20W	7~10W
110V	AC/DC 12V	110~220V	110~220V	AC/DC 12V
3000k/6000k	3000k/6000k	3000k/4000k/6000k	3000k/4000k/6000k	3000k/4000k/6000k
P6	P7	P7	P8	P9

光源類-燈管類



環保



減碳



節能



安全



STL



T8防水系列



T8半鋁系列



T8玻璃/塑膠系列



T5半鋁系列



T5塑膠系列

9W/20W(2/4ft)

9~20W(2~4ft)

9~20W(2~4ft)

9~20W(2~4ft)

9~20W(2~4ft)

110/220V

110/220V

110/220V

110~220V

110~220V

6500k

3000k/4000k/6000k

3000k/4000k/6000k

3000k/4000k/6000k

3000k/4000k/6000k

P10

P10

P10~11

P12

P12

燈具類



環保



減碳



節能



安全



STL



燈管型系列



嵌燈系列



軌道燈系列



吸頂燈(含感應)系列

2~4ft (單/雙管)

3~20W(一體/燈泡式)

3~20W(一體/燈泡式)

12~18W(一體式)

110/220V

110/220V

110/220V

110/220V

3000k/4000k/6000k

3000k/4000k/5700k/6000k

3000k/4000k/5700k/6000k

3000k/4000k/5700k

P13~14

P15~19

P20~23

P24~27

燈具類



環保



減碳



節能



安全



STL

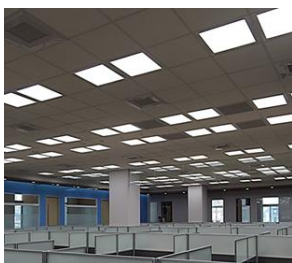

平板型系列



格柵燈具系列



天井燈系列



投射燈系列

36~48W(60x60)

三/四燈管 60x60

100~300W

10~150W

110/220V

110/220V

110/220V

110/220V

3000k/4000k/6000k

3000k/4000k/5700/6500k

3000k/4000k/5000/6500k

3000k/4000k/6000k

P28

P29

P30~31

P32

光源類-燈泡類



環保



減碳



節能



安全



STL

燈泡系列



產品編號	STKA-010	
功率 (W)	10	
色溫 (K)	3000	6000
亮度 (Lm)	950	1000
光效 (Lm/W)	95	100
尺寸 (mm)	E27 Φ60 H113	
演色性	>80	
輸入電壓 (V)	AC 110/220	

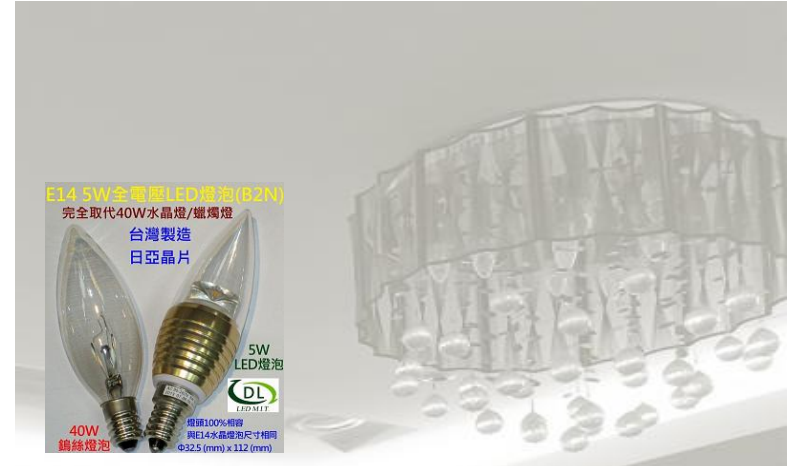

產品編號	STDL-005 光錐/拉尾	
功率 (W)	5	
色溫 (K)	2700	
亮度 (Lm)	280	
發光角 (度)	310	
尺寸 (mm)	E14 Φ32.5 H112	
演色性	95	
輸入電壓 (V)	AC 110/220	

3W/8W非常備品產品歡迎預約訂購

LED：日亞
台製

拉尾非常備品產品歡迎預約訂購

光源類-燈泡類



環保



減碳



節能



安全



STL



MR16/GU10系列



產品編號	STMR-163(白/銀)	STGU-103(白/銀)	STGU-105(白)	STGU-105(銀)
功率 (W)	3	3	5	5
色溫 (K)	3000/6000	3000/6000	3000/6000	6000~6800
亮度 (Lm)	160/180	160/180	270/300	270/300
發光角 (度)	38/60	38/60	40	38/60
尺寸 (mm)	Φ50 H52	Φ50 H58	Φ50 H58	Φ50 H78
演色性	>80	>80	>80	>80
輸入電壓 (V)	AC 110/220	AC 110/220	AC 110/220	AC 110/220



LED：台廠
台製

光源類-燈泡類



環保



減碳



節能



安全



STL

PAR系列



LED：台廠
台製



產品編號	STPA-165(古銅色)	STPA-165(銀)	STPA-301(白)
功率 (W)	5	5	10
色溫 (K)	3000	3000/6000	3000/6000
亮度 (Lm)	270	270/300	450/500
發光角 (度)	38	38/60	40
尺寸 (mm)	Φ50 H84	Φ50 H84	Φ95 H95
演色性	>80	>80	>80
輸入電壓 (V)	AC110/220	AC110/220	AC 110~220

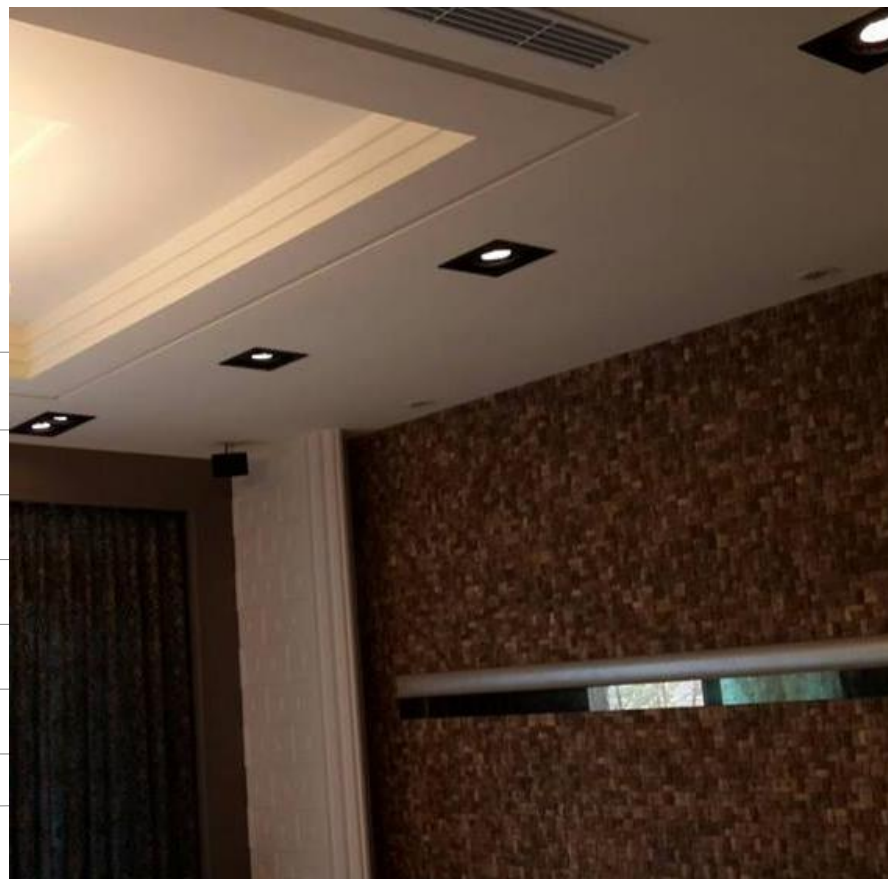

光源類-燈泡類



環保



減碳



節能



安全



STL

AR111系列

CE RoHS

輸入歐盟國家商品
符合歐盟指令



LED：台廠
台製

產品編號	STAR-010(白)	STAR-010(銀)	STAR-167(黑)
功率 (W)	10	10	10
色溫 (K)	3000/4000/6000	4000/6000	3000/6000
亮度 (Lm)	450/500/500	500/500	500/500
發光角 (度)	25	25	25
尺寸 (mm)	Φ111 H58	Φ111 H58	Φ111 H58
演色性	>80	>80	>80
輸入電壓 (V)	AC/DC 12	AC /DC 12	AC/DC 12



光源類-燈管類



環保



減碳



節能



安全



STL

T8燈管系列

LED：台廠



防水燈管

產品編號	STW8-A10	STW8-A20
功率 (W)	10	18
色溫 (K)	6500	6500
亮度 (Lm)	900	1800
發光角 (度)	310	310
尺寸 (mm)	Φ26 L2ft	Φ26 L4ft
演色性	>80	>80
輸入電壓 (V)	AC 110/220	AC110/220

LED：台廠



半鋁燈管

產品編號	STT8-A10	STT8-A20
功率 (W)	10	20
色溫 (K)	3000/4000/5700	3000/4000/5700
亮度 (Lm)	900/1000/1000	1800/2000/2000
發光角 (度)	135	135
尺寸 (mm)	Φ26 L2ft	Φ26 L3ft
演色性	>80	>80
輸入電壓 (V)	AC110/220	AC 110/220

光源類-燈管類



環保



減碳



節能



安全



STL

T8燈管系列

全塑燈管



LED：台廠



玻璃燈管

產品編號	STT8-P09	STT8-P14	STT8-P18	STT8-G18
功率 (W)	9	14	18	20
色溫 (K)	3000/4000/6000	3000/4000/6000	3000/4000/6000	3000/6000
亮度 (Lm)	810/1000/1000	1350/1400/1400	1650/1800/1800	1650/1800
發光角 (度)	270	270	270	270
尺寸 (mm)	Φ25.5 L2ft	Φ25.5 L3ft	Φ25.5 L4ft	Φ25.5 L4ft
演色性	>80	>80	>80	>80
輸入電壓 (V)	AC110/220	AC 110/220	AC 110/220	AC 110/220

光源類-燈管類



環保



減碳



節能



安全



STL

T5燈管系列



半鋁T5燈管



全塑T5燈管

產品編號	STT5-A10	STT5-A15	STT5-A20	STT5-P10	STT5-P15	STT5-P20
功率 (W)	10	15	20	9	14	18
色溫 (K)	3000/4000/6000	3000/4000/6000	3000/4000/6000	3000/4000/6000	3000/4000/6000	3000/4000/6000
亮度 (Lm)	900/1000/1000	1350/1500/1500	1800/2000/2000	810/900/900	1300/1450/1450	1650/1800/1800
發光角 (度)	135	135	135	135	135	135
尺寸 (mm)	Φ25.5 L2ft	Φ25.5 L3ft	Φ25.5 L4ft	Φ25.5 L2ft	Φ25.5 L3ft	Φ25.5 L4ft
演色性	>80	>80	>80	>80	>80	>80
輸入電壓 (V)	AC110/220	AC 110/220	AC 110/220	AC110/220	AC 110/220	AC 110/220

燈具類- 燈管燈具



環保



減碳



節能



安全



STL

T8 LED單/雙管專用

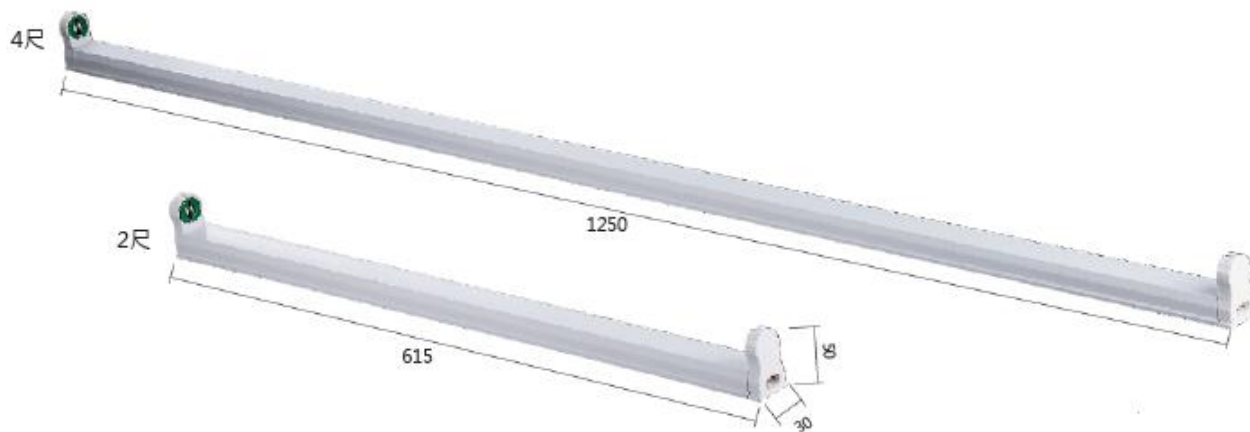

STKS4-5202
長度 尺寸 mm
1尺 L350 x W30 x H50
2尺 L615 x W30 x H50
3尺 L920 x W30 x H50
4尺 L1250 x W30 x H50

- ☆ 雙端供電
- ☆ 需搭配 LED T8 燈管使用
- ☆ 四尺最多串接不超過8支
- ☆ 1及3尺非常備產品歡迎事先預購



STT8S-036
長度 尺寸 mm
4尺 L1235 x W226x H45

- ☆ 雙端供電
- ☆ 需搭配 LED T8 燈管2支使用

燈具類- 燈管燈具



環保



減碳



節能



安全



STL

山形燈具：T8 LED專用

2呎單管

STKS4-2143

光源：T8 2呎×1管
尺寸：L629 x W110 x H80 mm
材質：磨光鋼板烤漆

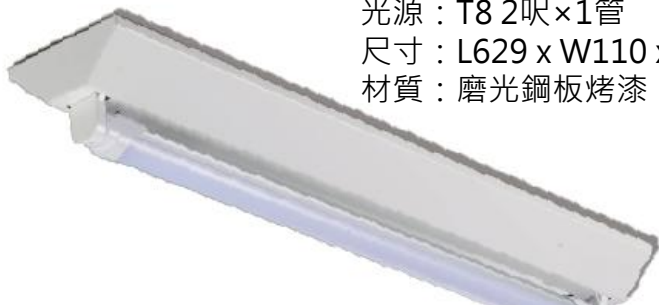

4呎單管

STKS4-4143

光源：T8 4呎×1管
尺寸：L1244 x W110 x H80 mm
材質：磨光鋼板烤漆

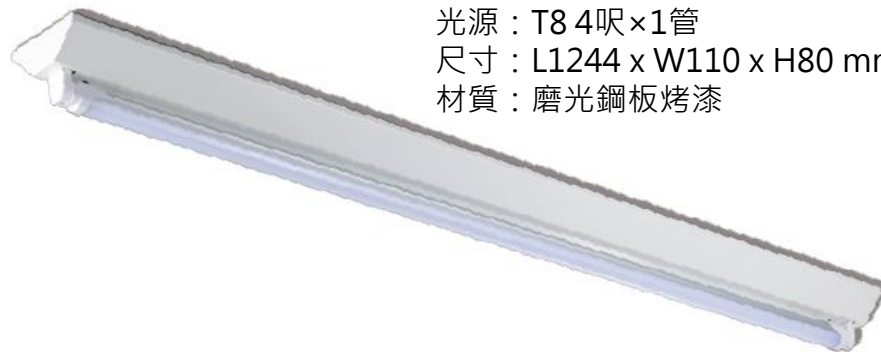

2呎雙管

STKS4-2243

光源：T8 2呎×2管
尺寸：L624 x W156 x H60 mm
材質：磨光鋼板烤漆



4呎雙管

STKS4-4243

光源：T8 4呎×2管
尺寸：L1243 x W156 x H60 mm
材質：磨光鋼板烤漆



☆ 雙邊入電 ☆ 旋轉式燈腳安裝方便
☆ 通過國家CNS認證 ☆ 台灣製造 ☆ 燈管另計



燈具類- 嵌燈燈具



環保



減碳



節能



安全



STL

泛用型系列

LED：台廠
台製



產品編號	STDL-007	STDL-012	STDL-016
功率 (W)	7	12	16
色溫 (K)	3000/4000/5700	3000/4000/5700	3000/4000/5700
亮度 (Lm)	450/500/500	1000/1100/1100	1350/1500/1500
發光角 (度)	120	120	120
尺寸 (mm)	開孔90	開孔150	開孔150
演色性	>80	>80	>80
輸入電壓 (V)	AC110/220	AC 110/220	AC 110/220

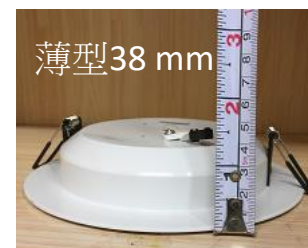

薄型38 mm

- ☆ 光學以均勻出光設計，比一般嵌燈較不刺眼。
- ☆ 薄型設計，樑下天花板安裝方便。

燈具類- 嵌燈燈具



環保



減碳



節能



安全



STL

投射型系列



RoHS



輸入歐盟國家商品
標準檢驗合格

輸入歐盟RoHS電子
產品有害物質測試

LED：台廠
台製



產品編號	STDL-003	STDL-005	STDL-007	STDL-010	STDL-035
功率 (W)	3	5	7	10	40
色溫 (K)	3000/4000/5700	3000/4000/6000	3000/4000/5700	3000/4000/5700	3000
光通量 (Lm)	160/180	270/300	340/375	450/500	3500
發光角 (度)	40	38/60	40	40	60
尺寸 (mm)	開孔50	開孔50	開孔90	開孔150	開孔155
顯色性	>80	>80	>80	>80	>80
輸入電壓 (V)	AC 110/220	AC 110/220	AC110/220	AC 110/220	AC 110/220

燈具類- 嵌燈燈具



環保



減碳



節能



安全



STL

投射型系列



- 180mm H50mm
- 嵌入孔：160X160mm
- 鐵製品

- L330mm W180mm H50mm
- 嵌入孔：310X160mm
- 鐵製品

- L480mm W180mm H50mm
- 嵌入孔：460X160mm
- 鐵製品

STKS5-4001



STKS5-4002



STKS5-4003



本頁光源另計

燈具類- 嵌燈燈具



環保



減碳



節能



安全



STL

投射型系列



STKS6-4061

- 195mm H100mm
- 嵌入孔：150X150mm
- 鐵製品



STKS6-4062

- 338mm W195mm H100mm
- 嵌入孔：300X150mm
- 鐵製品



STKS6-4063

- 480mm W195mm H100
- 嵌入孔：450X150mm
- 鐵製品



STKS6-4064

- 360mm H100mm
- 嵌入孔：300X300mm
- 鐵製品

本頁為光源另計

燈具類- 嵌燈燈具



環保



減碳



節能



安全



STL

投射型系列



STKS6-4065

- 150mm H80mm
- 嵌入孔：150X150mm
- 鐵製品



STKS6-4066

- 300mm W150mm H80mm
- 嵌入孔：300X150mm
- 鐵製品



STKS6-4067

- 450mm W150mm H80
- 嵌入孔：450X150mm
- 鐵製品



STKS6-4068

- 300mm H80mm
- 嵌入孔：300X300mm
- 鐵製品

本頁為光源另計

燈具類- 軌道燈具



環保



減碳



節能



安全



STL

投射型系列



STKS3-0621 軌道

A: 白色 B: 黑色

C: 1M D: 1.5M E: 2M F: 3M



十字接頭 L字接頭 T字接頭 一字接頭

燈具類- 軌道燈具



環保



減碳



節能



安全



STL

投射型系列

LED：台廠
台製



產品編號	STKD-097	STKD5-097	STKS5-6104	STKS5-6105	STKS5-6106
功率 (W)	3	5	7	9	12
色溫 (K)	3000/6000	3000/6000	3000/6000	3000/6000	3000/600
亮度 (Lm)	160/180	270/300	350/380	420/450	600/660
發光角 (度)	38/60	40	40	40	40
尺寸 (mm)	W130H150	W130H150	W75H145	W75H145	W75H145
演色性	>80	>80	>80	>80	>80
輸入電壓 (V)	AC 100/220	AC 110/220	AC 110/220	AC 110/220	AC 110/220

燈具類- 軌道燈具



環保



減碳



節能



安全



STL

投射型系列

LED：台廠
台製



產品編號	STKD-102	STKD-102	STKD-102	STKS3-0591
功率 (W)	7	9	12	10
色溫 (K)	3000/6000	3000/6000	3000/6000	3000/600
亮度 (Lm)	350/380	420/450	600/660	500/550
發光角 (度)	38/60	40	40	40
尺寸 (mm)	W130H150	W130H150	W75H145	W70H121L210
演色性	>80	>80	>80	>80
輸入電壓 (V)	AC 110/220	AC 110/220	AC 110/220	AC 110/220

☆ STKD-102系列燈具顏色: 白/黑

燈具類- 軌道燈具



環保



減碳



節能



安全



STL

投射型系列

LED：台廠
台製



產品編號	STKS4-1115	STKS4-1115	STKS4-1115
功率 (W)	7	9	12
色溫 (K)	3000/6000	3000/6000	3000/6000
亮度 (Lm)	350/380	420/450	600/660
發光角 (度)	38/60	40	40
尺寸 (mm)	W130H150	W130H150	W75H145
演色性	>80	>80	>80
輸入電壓 (V)	AC 110/220	AC 110/220	AC 110/220

☆ 燈具顏色: 白/黑

燈具類- 吸頂燈具



環保



減碳



節能



安全



STL

12W泛用系列

LED：台廠
台製



產品編號	STKS-A12	STKS-B12	STKS-D12	STKS-E12
功率 (W)	12	12	12	12
色溫 (K)	3000/4000/60000	3000/4000/6000	3000/4000/5700	3000/4000/5700
亮度 (Lm)	960/1050	960/1050	960/1050	960/1050
發光角 (度)	230	230	230	230
尺寸 (mm)	Φ 250H80	Φ 250H80	Φ 250H85	Φ 250H85
演色性	>80	>80	>80	>80
輸入電壓 (V)	AC 110/220	AC 110/220	AC 110/220	AC 110~220

燈具類- 吸頂燈具



環保



減碳



節能



安全



STL

12W微波感應系列



LED：台廠
台製

產品編號	STKC-A12	STKC-B12	STKC-E12
功率 (W)	12	12	12
色溫 (K)	3000/4000/60000	3000/4000/6000	3000/4000/5700
亮度 (Lm)	960/1050	960/1050	960/1050
發光角 (度)	230	230	230
尺寸 (mm)	Φ 250H80	Φ 250H80	Φ 250H85
演色性	>80	>80	>80
輸入電壓 (V)	AC 110/220	AC 110/220	AC 110~220



功能選擇：
1. on-Off
2. on 100% -off 30%

光源類-吸頂燈具



環保



減碳



節能



安全



STL

18W 泛用型系列

LED：台廠
台製



產品編號	STKS-A18	STKS-B18	STKS-C18	STKS-D18	STKS-E18
功率 (W)	18	18	18	18	18
色溫 (K)	3000/4000/6000	3000/4000/6000	3000/4000/6000	3000/4000/6000	3000/4000/6000
亮度 (Lm)	1450/1600	1450/1600	1450/1600	1500/1650	1450/1600
發光角 (度)	230	230	230	230	230
尺寸 (mm)	Φ 400H100	Φ 400H100	Φ 400H95	Φ 400H105	Φ 400H105
演色性	>80	>80	>80	>80	>80
輸入電壓 (V)	AC 110/220	AC 110/220	AC 110/220	AC 110/220	AC 110/220

光源類-吸頂燈具



環保



減碳



節能



安全



STL

18W微波感應型系列

LED：台廠
台製



產品編號	STKC-A18	STKC-B18	STKC-C18	STKC-D18	STKC-E18
功率 (W)	18	18	18	18	18
色溫 (K)	3000/4000/6000	3000/4000/6000	3000/4000/6000	3000/4000/6000	3000/4000/6000
亮度 (Lm)	1450/1600	1450/1600	1450/1600	1500/1650	1450/1600
發光角 (度)	230	230	230	230	230
尺寸 (mm)	Φ 400H100	Φ 400H100	Φ 400H95	Φ 400H105	Φ 400H105
演色性	>80	>80	>80	>80	>80
輸入電壓 (V)	AC 110	AC 110	AC 110	AC 110	AC 110

☆ 微波感應器置放燈具中不破壞美感

光源類-吸頂燈具



環保



減碳



節能



安全



STL

36W 泛用型系列



LED：台廠
台製

產品編號	STKS-A36	STKS-B36	STKS-C36	STKS-D36
功率 (W)	36	36	36	36
色溫 (K)	3000/4000/6000	3000/4000/6000	3000/4000/6000	3000/4000/6000
亮度 (Lm)	2900/3200	2900/3200	2900/3200	2900/3200
發光角 (度)	230	230	230	230
尺寸 (mm)	Φ 400H100	Φ 400H100	Φ 400H95	Φ 400H105
演色性	>80	>80	>80	>80
輸入電壓 (V)	AC 110/220	AC 110/220	AC 110/220	AC 110/220

光源類-吸頂燈具



環保



減碳



節能



安全



STL

36W 壁切控制型系列



LED：台廠
台製

產品編號	STKC-A36	STKC-B36	STKC-C36	STKC-D36
功率 (W)	36	36	36	36
色溫 (K)	3000/4000/6000	3000/4000/6000	3000/4000/6000	3000/4000/6000
亮度 (Lm)	2900/3200	2900/3200	2900/3200	2900/3200
發光角 (度)	230	230	230	230
尺寸 (mm)	Φ 400H100	Φ 400H100	Φ 400H95	Φ 400H105
演色性	>80	>80	>80	>80
輸入電壓 (V)	AC 110/220	AC 110/220	AC 110/220	AC 110/220

**電控節能：
以壁切開關切換**

壁切開關第一次 on：全亮

壁切開關再一次 off-on：50%亮

壁切開關再一次 off-on：50%亮

壁切開關再一次 off-on：全亮

壁切開關依此循環，若期間開關
按到 off 5秒以上，然後on則跳
回初始啟動全亮。

光源類-吸頂燈具



環保



減碳



節能



安全



STL

36W 壁切控制 變色型系

LED：台廠
台製



產品編號	STCC-A36	STCC-B36	STCC-C36	STCC-D36
功率 (W)	36	36	36	36
色溫 (K)	3000/4000/6000	3000/4000/6000	3000/4000/6000	3000/4000/6000
亮度 (Lm)	2900/3200	2900/3200	2900/3200	2900/3200
發光角 (度)	230	230	230	230
尺寸 (mm)	Φ 400H100	Φ 400H100	Φ 400H95	Φ 400H105
演色性	>80	>80	>80	>80
輸入電壓 (V)	AC 110/220	AC 110/220	AC 110/220	AC 110/220

電控節能： 以壁切開關切換

壁切開關第一次 on：全亮 4000K

壁切開關再一次 off-on：50% 黃光

壁切開關再一次 off-on：50% 白光

壁切開關再一次 off-on：全亮4000K

壁切開關依此循環，若期間開關按到 off 5秒以上，然後on則跳回初始啟動全亮。

光源類-吸頂燈具



環保



減碳



節能



安全



STL

明裝系列

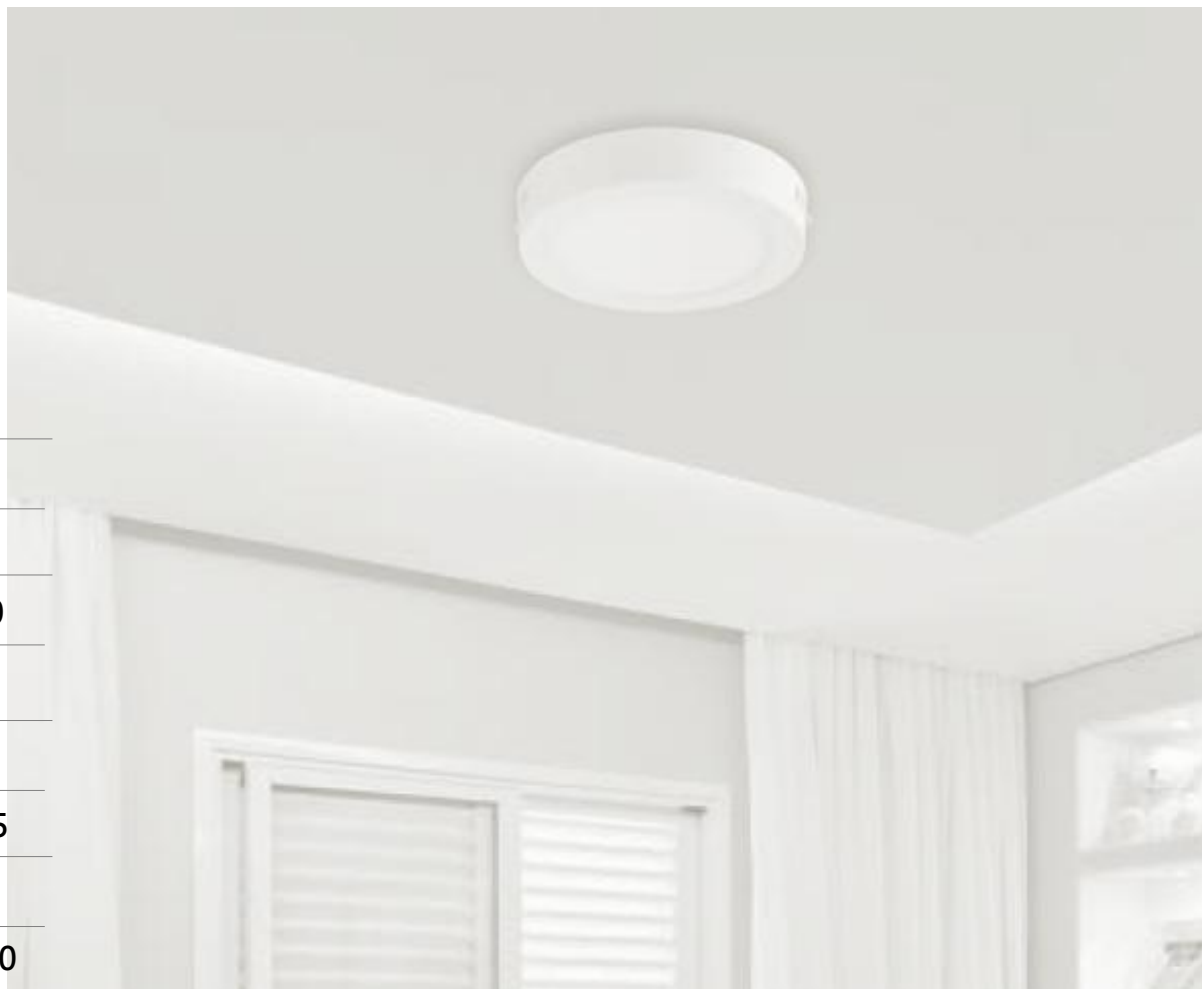

產品編號	STKP-012	STKP-018
功率 (W)	12	18
色溫 (K)	4000/6000	4000/6000
顏色	白	白
發光角 (度)	120	120
尺寸 (mm)	Φ170xH35	Φ225xH35
演色性	>80	>80
輸入電壓 (V)	AC 110/220	AC 110/220

燈具類-



環保



減碳



節能



安全



STL

平板燈具

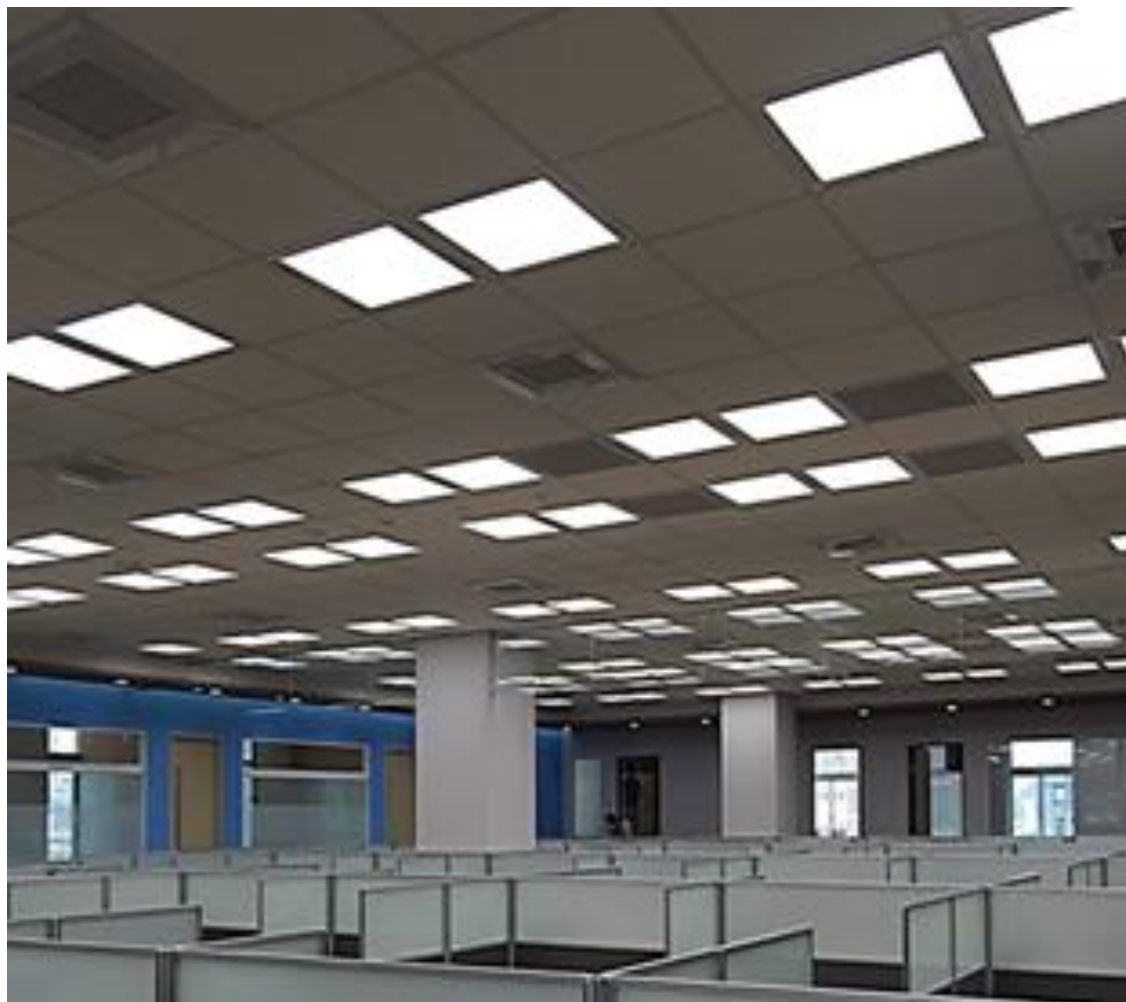

產品編號	STPL-036	STSL-048
功率 (W)	36	48
色溫 (K)	3000/4000/6000	3000/4000/6000
亮度 (Lm)	3080/3420	4000/4500
發光角 (度)	110/120	110/120
尺寸 (mm)	L600W600H15	L600W600H15
演色性	>80	>80
輸入電壓 (V)	AC 110/220	AC 110/220

燈具類-



環保



減碳



節能



安全



STL

格柵燈具：T8 LED專用



LED吸、嵌兩用輕鋼架

STKLA-203X

- * 消耗功率: T8 2 尺x3
- * 需搭配T8 LED 燈管使用(另計)
- * 尺寸：□ 601mm H55mm



LED吸、嵌兩用輕鋼架

STKLA-204X

- * 消耗功率: T8 2 尺x4
- * 需搭配T8 LED 燈管使用(另計)
- * 尺寸：□ 601mm H55mm



- * 材質：磨光鋼板烤漆+ 鏡面鋁板
- * 通過CNS 認證

- * 西德製鋁板不易生鏽
- * 燈具為台灣製造

燈具類- 天井燈



環保



減碳



節能



安全



STL



高天井燈 HIGH BAY LIGHT

100瓦 / 150瓦 / 200瓦 / 300瓦

電氣特性

輸入電壓：AC 90-264V, 50/60 赫茲

操作溫度：-30°C 到 +50°C

壽命 (L70): 60,000 小時

出光角：60°, 100° (100/150/200 瓦)

30°, 60°, 100° (300 瓦)

光型

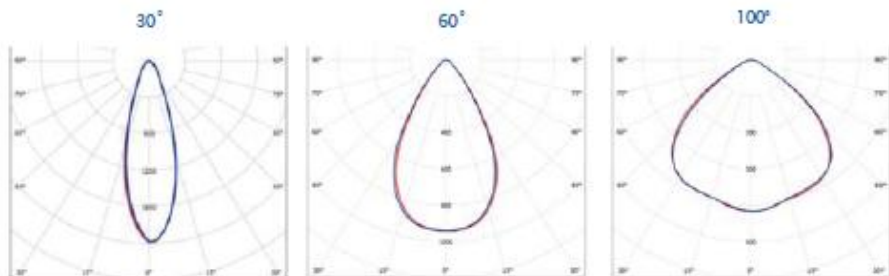

cd/klm
—c0-C130 —c90-C270

尺寸圖

單位: mm

100瓦 | 重量: 2.8 公斤

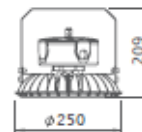

150瓦/200瓦 | 重量: 3 公斤



300瓦 | 重量: 7.5 公斤

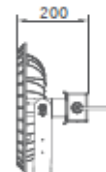
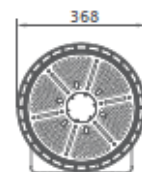

應用

倉庫
工廠照明
零售賣場
大賣場

產品特色

- 節能效果佳，系統效率達每瓦 120 流明 (Ra > 80)
- 輕量化設計，安裝便利
- 使用不銹鋼支架；堅固耐用，可調整角度
- 高耐候等級的粉體烤漆
- 戶外 IP65 防水設計



IP65



燈具類- 天井燈

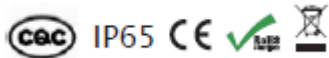

環保



減碳



節能



安全



STL



WING LIGHT

150W

尺寸

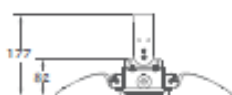
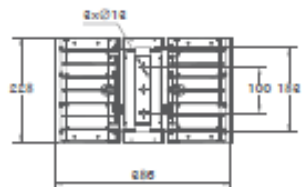

From 0 to 60 degrees adjustable



光型

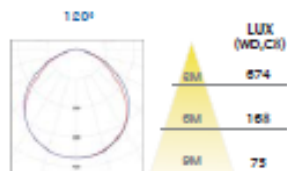
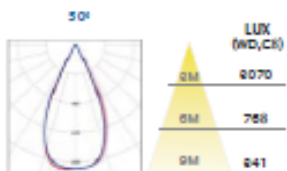

HALL LIGHT

240W

尺寸

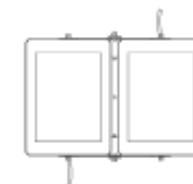

重量 10.9kg

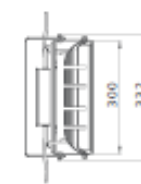

光型

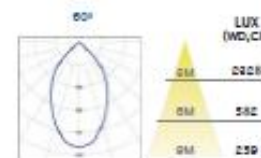
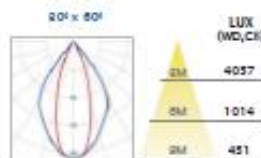

燈具類- 戶外投射燈具



環保



減碳



節能



安全



STL



LED：台廠
台製

產品編號	STWL-010	STWL-030	STWL-050	STWL-100	STWL-150
功率 (W)	10	30	50	100	150
色溫 (K)	3000/6000	3000/6000	3000/6000	3000/6000	3000/6000
亮度 (Lm)	1000/1100	4500/5000	5500/6000	10000/11000	15000/16500
發光角 (度)	120	120	90/120	90/120	90/120
尺寸 (mm)	L115W75H90	L195W50H230	L260W250H130	L380W250H130	L530W250H130
演色性	>70	>80	>80	>80	>80
輸入電壓 (V)	AC 110/220	AC 110/220	AC 110/220	AC 110/220	AC 110~220

IP65以上 30~150W使用明緯驅動器

燈具類- 投光燈具



環保



減碳



節能



安全



STL

節慶使用、室內情境佈置、戶外樹上、建築大樓等佈置裝飾

LED星星燈 STNKD-47

- 尺寸：10公尺，總燈數100燈，可外接跳機
- 瓦數/顏色：4W - 紅、黃、綠、藍、紫、桃紅、彩色
7W - 藍白、白、暖白
- 輸入電壓：110V/220V，電流：0.058A
- * 防水等級：IP44

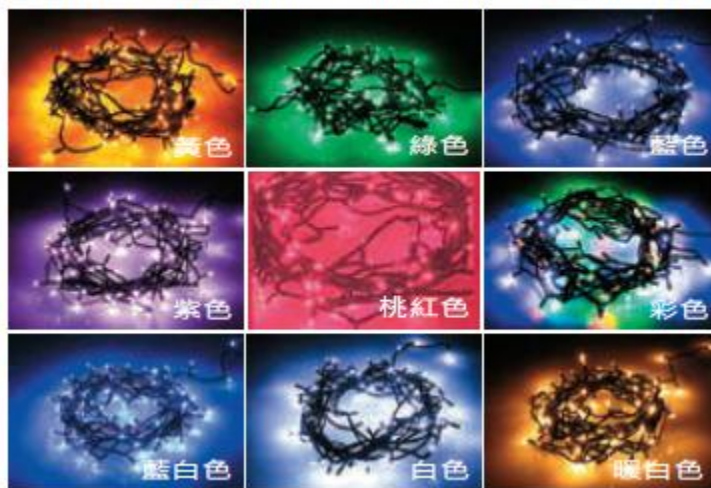

LED網格燈 STNKD-48

- 尺寸：180cmx120cm，總燈數120燈，可外接跳機
- 瓦數/顏色：4W - 紅、黃、綠、藍、紫、桃紅、彩色
7W - 藍白、白、暖白
- 輸入電壓：110V/220V，電流：0.058A
- * 防水等級：IP44

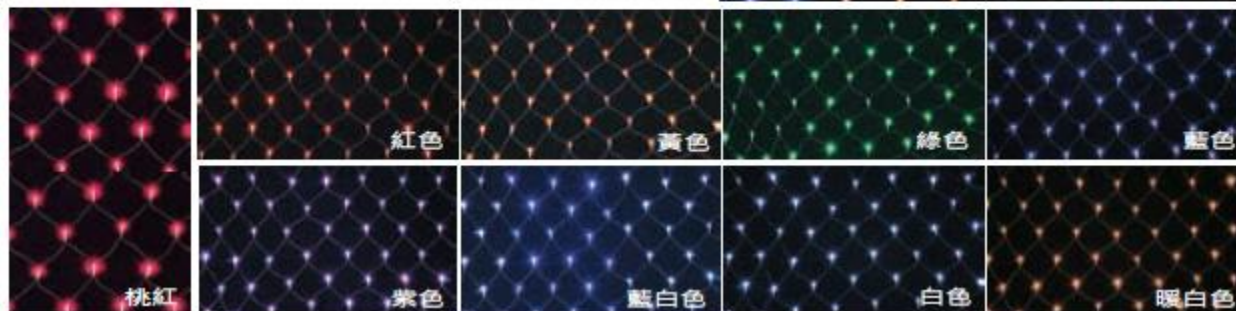

燈具類- 投光燈具



環保



減碳



節能



安全



STL

- 尺寸：寬3公尺，下垂長度為30、60、90cm，總燈數100燈，可外接跳機
- 瓦數/顏色：4W - 藍、紫、桃紅、彩
7W - 藍白、白、暖白
- 輸入電壓：110V/220V，電流：0.058A
- * 防水等級：IP44

LED窗簾燈 STNKD-49

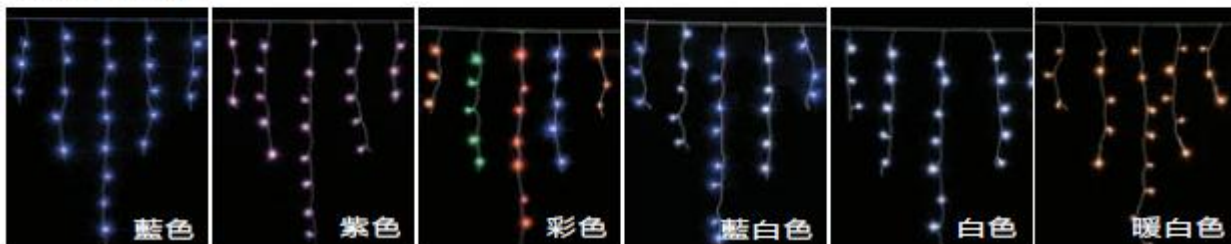

LED網格燈 STNKD-56

- 尺寸：長度2.5米
下垂長度為30、60、90cm
每組共5個雪花，雪花間隔50cm
- 輸入電壓：110V/220V

顏色	雪花尺寸/數量	燈數	註明
藍光	8" / 5個	6燈/片；30燈/組	不跳動
白光	8" / 5個	6燈/片；30燈/組	不跳動
藍白光	8" / 5個	12燈/片；60燈/組	可跳動(內含跳機)
藍白光	8"/3個+11"/2個	12燈/片；60燈/組	可跳動(內含跳機)





以上熱銷產品之外
~歡迎您到公司選購~



旭環科技照明有限公司

303 新竹縣湖口鄉八德路一段590號

電話：(03)569-0055

傳真：(03)569-0933

統一編號：54121662

公司網址：<http://www.stl-led-lighting.com/>